

UNIFIX connector

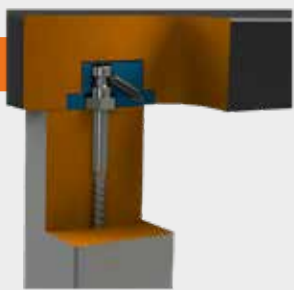

PLANOGRAT burr strip

burr strip



INDUFIX connector



MINIGRAT burr strip

burr strip

Available at
our retail partners

UNIFIX

universal connector



- extremely stable
- invisible use
- versatile use
- easy to mount
- flush mounting

*Heavy-duty connection
for furniture construction*



Functionality

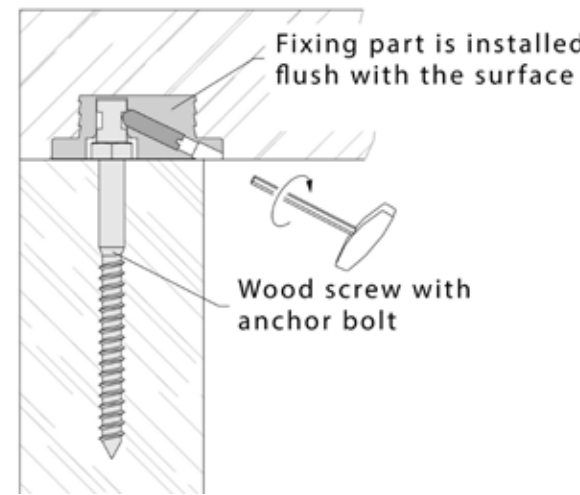

from panel thickness 30 mm

Applications

- furniture making
- mobile components
- garden furniture
- staircase construction
- store construction
- exhibition stand construction



table base mounting



Anchor screws for wood and metal



- ø 40 mm
- ø 50 mm
- ø 60 mm
- ø 70 mm
- ø 80 mm

Bench and table fitting



Bed hardware



INDUFIX

table leg connector



- extremely stable
- twist-proof
- simple
- flush with the surface
- self-explanatory
- inexpensive
- universal

Functionality

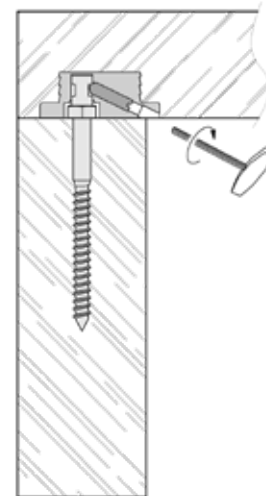

Flush mounted

from panel thickness 25 mm



ideal for table leg supports

Semi-deep installation

from panel thickness 18 mm



PLANOGRAT

burr strip



from panel thickness 25 mm

- flush installation with plane cover
- quickly installed by hammering in the clamping strip
- extremely resistant to bending due to 2 stable rolled steel profiles
- also suitable for pull-out tables

Scope of delivery

- 2 rolled steel profiles for stable shaping
- 1 aluminium profile as flush cover

Functionality

Functionality

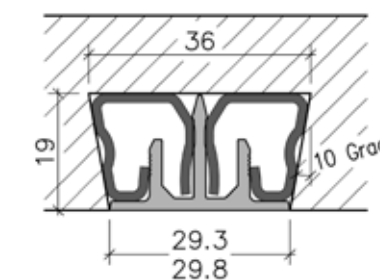

cross section

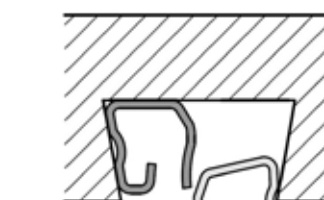

installation

MINIGRAT

burr strip



from panel thickness 19 mm

- ideal for solid wood fronts with a thickness of 19 mm or more
- quickly installed by hammering in the steel profile
- no miling through at the front edges
- very bend resistant steel profile

Optical coverage

- with a black matte magnetic strip
- almost flush with the surface

Functionality

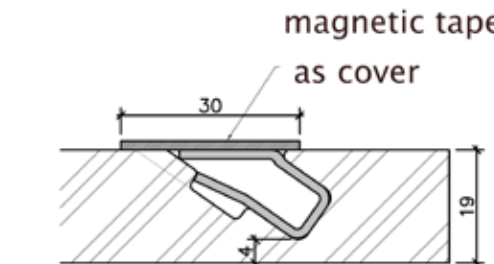

cross section

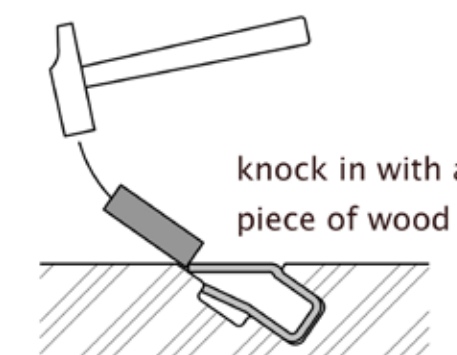

installation



Rammerstorfer OG

TIVER

table extension

ideal for solid table tops



Table extensions attached absolutely horizontally

www.tischverlängerung.at

RAMTI

table connector

ideal for the hospitality industry



Detail dimensions

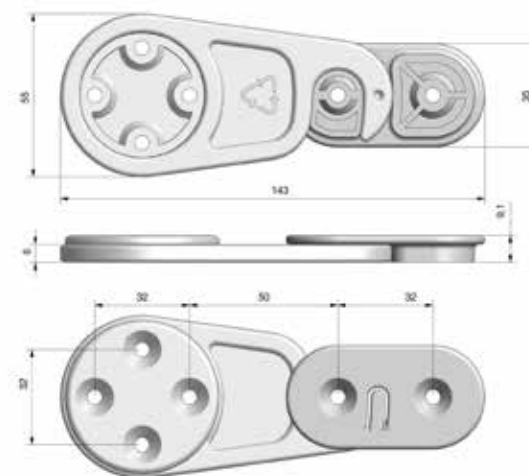

www.tischverlängerung.at

TARAM

tray support

ideal for lightweight walls



Detail dimensions



- compact dimensions
- inclination adjustable by turning

www.tablarträger.at

DÜBELKLEMME

gluing aid



NEW

Functionality

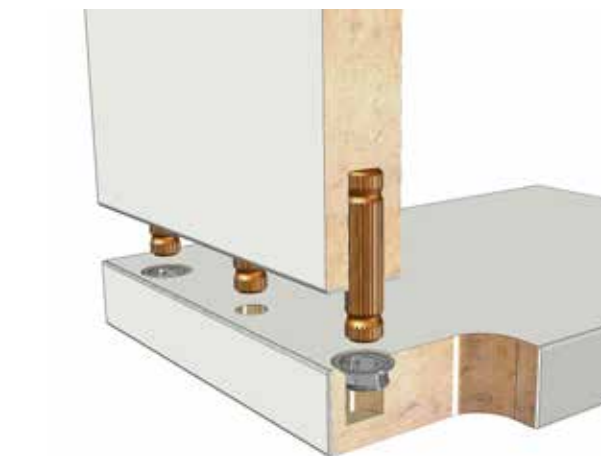

from corpus thickness 16 mm

Corpus glueing:

- without cabinet clamp
- without screw clamp

- almost tool-free assembly
- saves time and energy
- ideal for self-assembly furniture industry

- For use in the area of the clamp, only a 10 mm hole with a countersunk bevel is required
- During assembly, all holes must be glued and the corpus parts are only joined together with a rubber hammer

No clamps necessary!

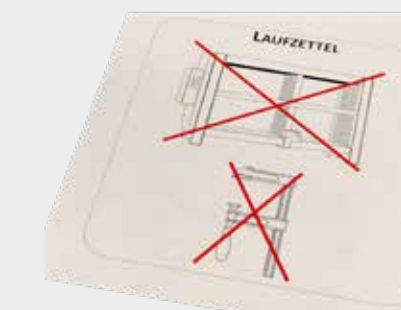

www.dübelklemme.at



TIVER

table extension



RAMTI

table connector



TARAM

tray support

Fitting for table extension

- easy installation
- thin, compact profile
- anodized aluminium surface
- aesthetic design



Plug-in and screw-on fitting

- very stable design
- star knob screw for fixation
- simple retroactive extension

Table top connector

- safe and high load-bearing connection
- tool-less, one person assembly
- ideal use for insertion plates

Insertion plate between two tables

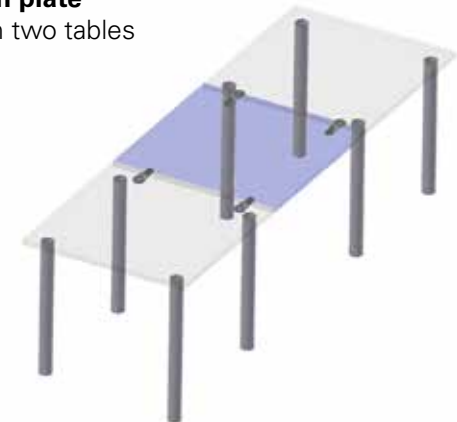

Functionality

Tray support on suspension rail

- multiple screw connection for perfect support
- easy and time-saving installation
- continuous adjustment of the fitting
- possible to put several brackets on one rail

Suspension rails made of aluminium

- easily shortened to required length
- standard length: 80 cm
- standard length: 192.5 cm
- pre-drilled rail for simple wall mounting



Rail length: 80 cm / 192.5 cm

Available at our retail partners